

Detail - A



Detail - B



See detail B

See detail A

See detail C



Bag for Shipping Top



Bag for Shipping Frame

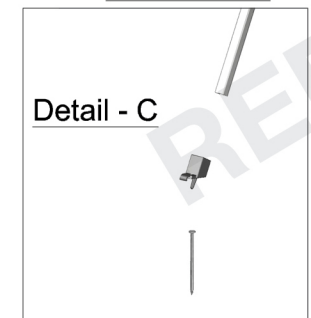

Detail - C

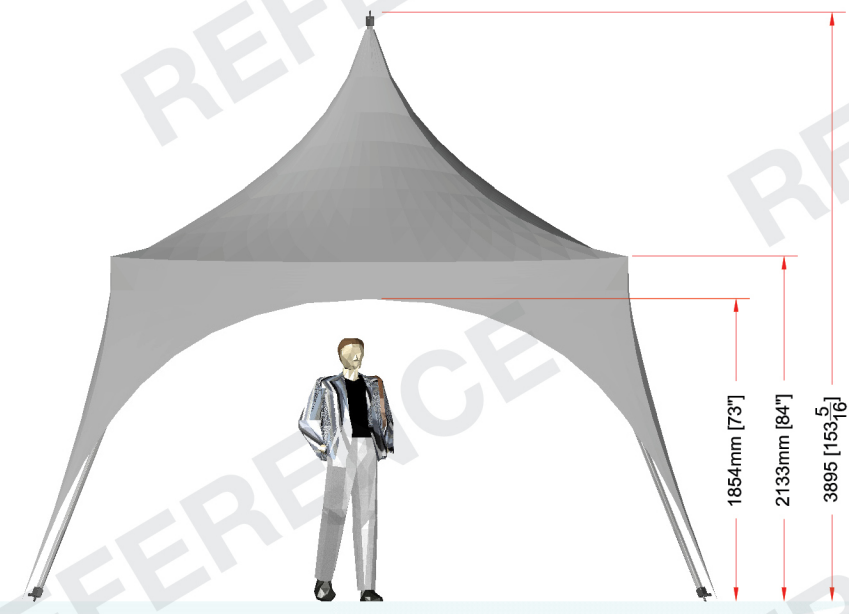

Assembled tent

This drawing is for reference purposes only. Contact Tentnology® for specific details and site requirements.

Designed to meet or exceed the following requirements : Fabric conforms to Fire CPA184 with water repellent finish.
 User Note: Tent integrity is a direct function of installation quality. Follow installation instructions, adding stakes as conditions require. Do not exceed design parameters or local ordinances for public assembly. Stakes & guying indicated on this drawing may or may not be appropriate for soil & site conditions.
 When in doubt, consult local engineer. Dimensions shown in millimetres unless stated otherwise. **CLIMBING ON TENT CAN RESULT IN INJURY OR DEATH**

\\vfs\tentshare\A_Product\AAMasterEngineer\50.34.000.dwg Printing: May 31, 2016-11:57

tentnology co.
 15427 66th Avenue Surrey B.C. Canada V3S 2A1
 Tel: (604) 597-8368 Fax: (604) 597-8749 e-mail: tent@tentnology.com

Bumbershoot Open 4.5m General Arrangement		
Project: Bumbershoot	Scale: NTS	Sheet No: 1 of 1
Dwg By: LC	Date: 26 Nov 09	File: 50.34.000
Cl'k'd By: ALI	App'v'd: RB	

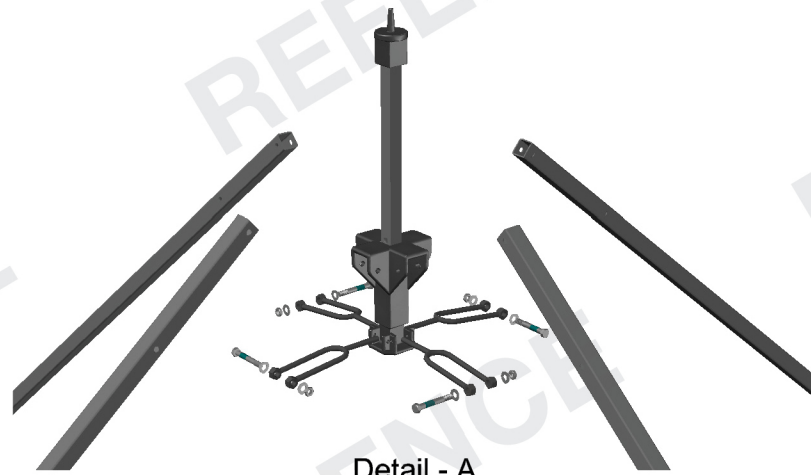
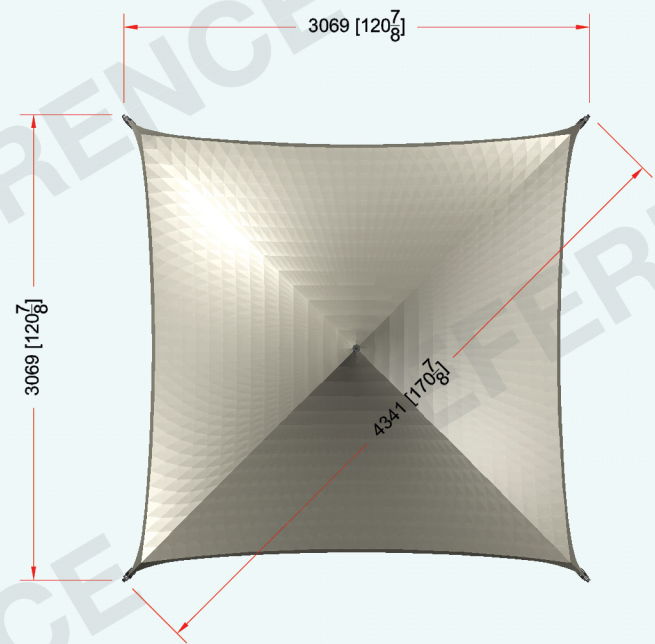

Detail - A

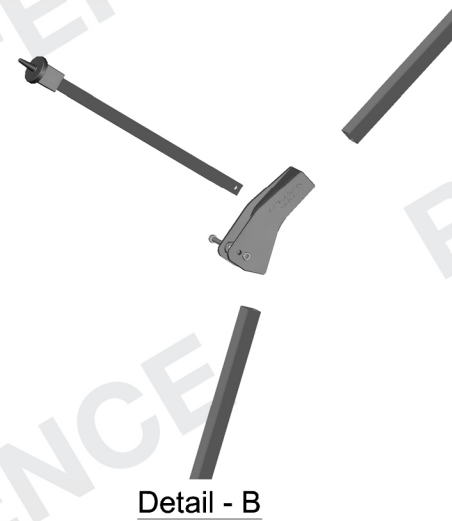

Detail - B

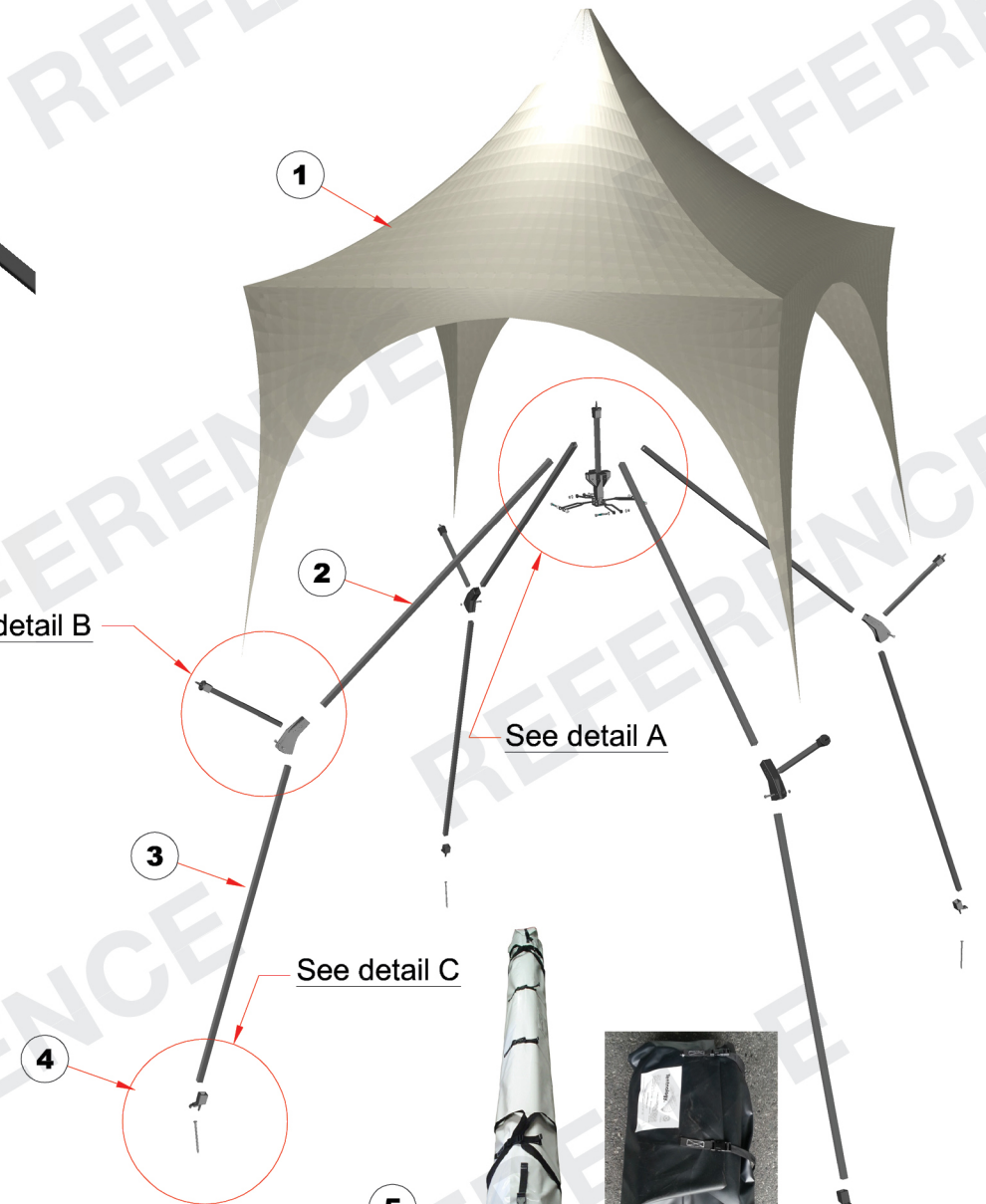

See detail B

See detail A

See detail C

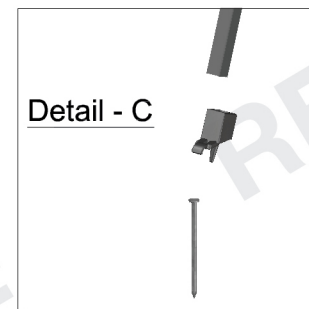

Detail - C



Bag for Shipping Top
Bag for Shipping Frame



Assembled tent

This drawing is for reference purposes only. Contact Tentnology® for specific details and site requirements.

Designed to meet or exceed the following requirements: Fabric conforms to Fire CPA184 with water repellent finish.
 User Note: Tent integrity is a direct function of installation quality. Follow installation instructions, adding stakes as conditions require. Do not exceed design parameters or local ordinances for public assembly. Stakes & guying indicated on this drawing may or may not be appropriate for soil & site conditions.
 When in doubt, consult local engineer. Dimensions shown in millimetres unless stated otherwise. **CLIMBING ON TENT CAN RESULT IN INJURY OR DEATH**

\\vfs\tentshare\A_Product\AAMasterEngineer\50.34.010.dwg Printing: May 31, 2016-11:50

tentnology co.

15427 66th Avenue Surrey B.C. Canada V3S 2A1
 Tel: (604) 597-8368 Fax: (604) 597-8749 e-mail: tent@tentnology.com

**Presto System 3.0M Open
 General Arrangement**

Project: Presto	Date: 30 Nov 09	Scale: NTS	Sheet No: 1 of 1
Dwg By: LC	App'd: <i>RB</i>	50.34.010	